

ANNKE

WE DELIVER SAFETY

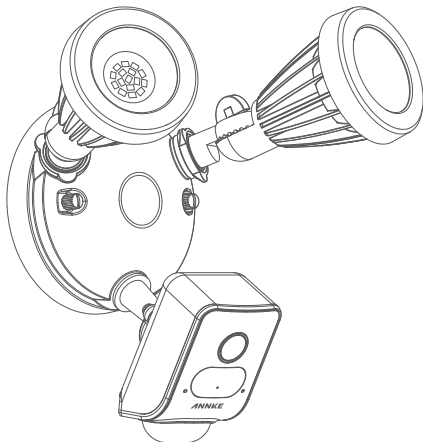

AI Floodlight Cam

Regulatory Information

FCC compliance

This equipment has been tested and found to comply with the limits for a Class B digital device, pursuant to part 15 of the FCC Rules. These limits are designed to provide reasonable protection against harmful interference in a residential installation. This equipment generates, uses and can radiate radio frequency energy and, if not installed and used in accordance with the instructions, may cause harmful interference to radio communications. However, there is no guarantee that interference will not occur in a particular installation. If this equipment does cause harmful interference to radio or television reception, which can be determined by turning the equipment off and on, the user is encouraged to try to correct the interference by one or more of the following measures:

- Reorient or relocate the receiving antenna.
- Increase the separation between the equipment and receiver.
- Connect the equipment into an outlet on a circuit different from that to which the receiver is connected.
- Consult the dealer or an experienced radio/TV technician for help.

FCC Conditions

This device complies with part 15 of the FCC Rules. Operation is subject to the following two conditions:

1. This device may not cause harmful interference.
2. This device must accept any interference received, including interference that may cause undesired operation.

EU Conformity Statement



This product and -if applicable -the supplied accessories too are marked with "CE" and comply therefore with the applicable harmonized European standards listed under the EMC Directive 2004/108/EC, the RoHS Directive 2011/65/EU.



2012/19/EU (WEEE directive): Products marked with this symbol cannot be disposed of as unsorted municipal waste in the European Union. For proper recycling, return this product to your local supplier upon the purchase of equivalent new equipment, or dispose of it at designated collection points. For more information see: www.recyclethis.info



2006/66/EC (battery directive): This product contains a battery that cannot be disposed of as unsorted municipal waste in the European Union. See the product documentation for specific battery information. The battery is marked with this symbol, which may include lettering to indicate cadmium (Cd), lead (Pb), or mercury (Hg). For proper recycling, return the battery to your supplier or to a designated collection point. For more information see: www.recyclethis.info



Safety Instruction

These instructions are intended to ensure that user can use the product correctly to avoid danger or property loss.

The precaution measure is divided into "Warnings" and "Cautions"

Warnings: Serious injury or death may occur if any of the warnings are neglected.

Cautions: Injury or equipment damage may occur if any of the cautions are neglected.

	
Warnings: Follow these safeguards to prevent serious injury or death.	Cautions: Follow these precautions to prevent potential injury or material damage.



Warnings

- Proper configuration of all passwords and other security settings is the responsibility of the installer and/or end-user.
- In the use of the product, you must be in strict compliance with the electrical safety regulations of the nation and region. Please refer to technical specifications for detailed information.
- Input voltage should meet both the SELV (Safety Extra Low Voltage) and the Limited Power Source with 100~240 VAC or 12 VDC according to the IEC60950-1 standard. Please refer to technical specifications for detailed information.
- Do not connect several devices to one power adapter as adapter overload may cause over-heating or a fire hazard.
- Please make sure that the plug is firmly connected to the power socket.
- If smoke, odor or noise rise from the device, turn off the power at once and unplug the power cable, and then please contact the service center.

Smart Security at Every Corner of Your Home

Your AI floodlight cam lets you extend security around your entire property.

Now, you'll always be the first to know when someone's on your yard, and you can watch over your home from anywhere. Monitor your home, prevent crime and protect your property – all from your phone or tablet.

This manual is for informational purposes only. Working with electricity can be dangerous unless proper safety precautions are taken. If you are not comfortable or are inexperienced with the processes and tools described

AI Floodlight Cam

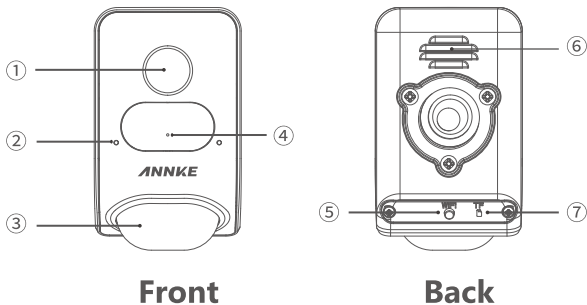

①	1080P HD Camera Lens	⑤	Reset Button
②	Indicator Light	⑥	100-dB Security Siren
③	PIR infrared body sensor	⑦	TF Card Slot
④	Two-Way Talk		

Indicator Light Status

Indicator Light Status	Status statement
Red indicator is on	Camera starts up,continue for 15 seconds
Red indicator blinks	Red indicator blinks (every 1 sec): WiFi configuration standby
Blue indicator blinks	1. Blue indicator slow blinks (every 1 sec): Connecting to the local internet. 2. Blue indicator quick blinks (every 0.25 sec): Connecting to the cloud server and waiting for configuration.
Blue indicator is on	Server connected successfully
Red and blue indicator blinks alternately	2 indicators blink alternately (every 1 sec): Device upgrading Please keep charging

Mounting Position And Protection Zone

Check Wi-Fi availability



The AI Floodlight Cam needs a stable and sufficient strong Wi-fi connection.



Please choose the location where you would like to position your AI Floodlight Cam and check the strength of the Wi-fi signal using your smart phone.

The table above indicates whether the WiFi signal is strong enough for use in combination with the AI Floodlight Cam.



Bag o' Screws

Find the right ones to attach the mounting bracket to your junction box without running to the hardware store.



Wire Nuts (3)

Connect the junction box and floodlight camera 3-wire connector.



Cap Nuts (2)

Use these to secure your Floodlight Cam to the posts on the mounting bracket to complete the installation.



Hook

Hang your Floodlight Cam while connecting the wires.

How it all fits together

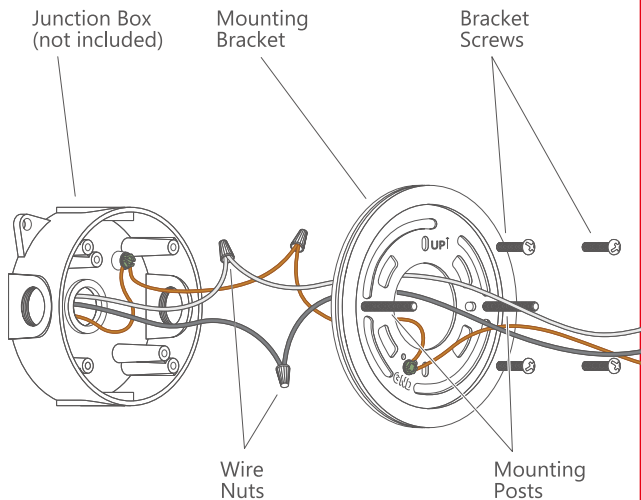

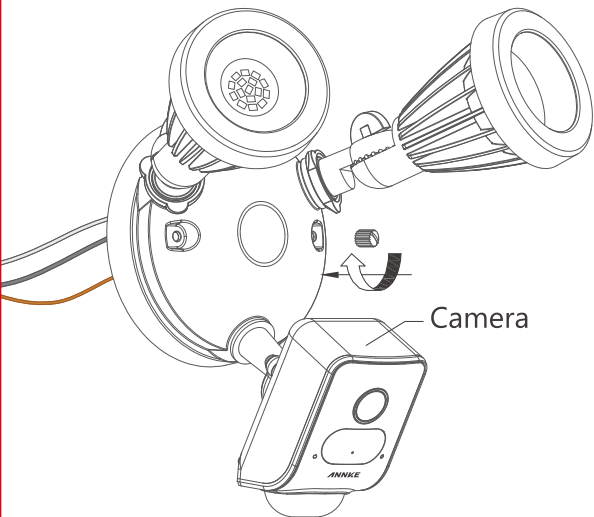

Ideal installation height of motion detection

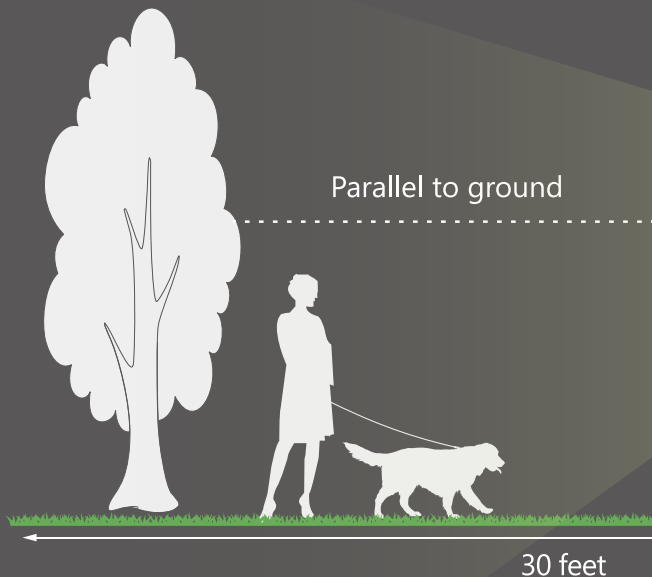

Installed 9 feet above and parallel to the ground, the PIR detector's sensor can be optimized to detect moving human body at a distance of up to 30 feet. When the suspicious intrusion mode is turned on, it can detect moving human body within the range of 15 feet away from the camera.

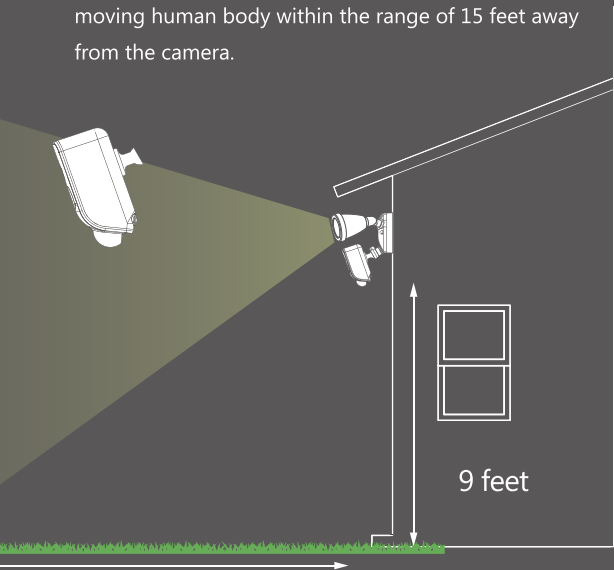

Shut power off at the fusebox

Turn off power to your floodlight circuit at the fusebox to ensure no power is being sent.





Risk of electrical shock:

- Installation and wiring must be performed by a licensed electrician.
- Shut off power at the fusebox before installing.
- Verify that the supply voltage is correct. Connect fixture to a 100VAC-240VAC 50/60Hz power source.
- Properly ground fixture.
- Properly ground fixture.

CAUTION: Risk of fire

- Do not install near combustible or flammable surfaces.

NOTICE:

- Do not connect this light fixture to a dimmer switch or timer.
- Floodlight Cam must be installed on a wall and on a junction box.

Installation instructions

- A. Turn OFF power at the circuit breaker box.
- B. Loosen the knobs on the light fixtures to rotate them out of the way and allow access to the mounting screws.

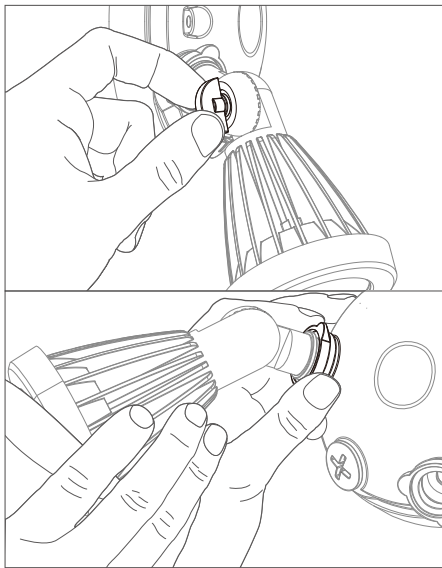

C. Install the mounting bracket with the two posts level with the ground or level with your wall if mounting vertically on an overhand.

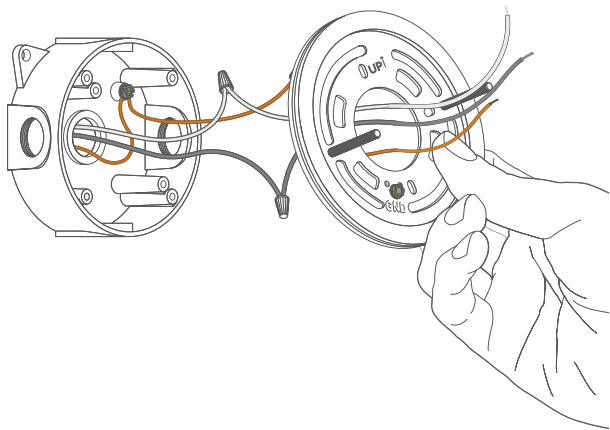

D. Make sure your existing wires come through the middle of the bracket. Attach the bracket to your junction box using at least two screws.

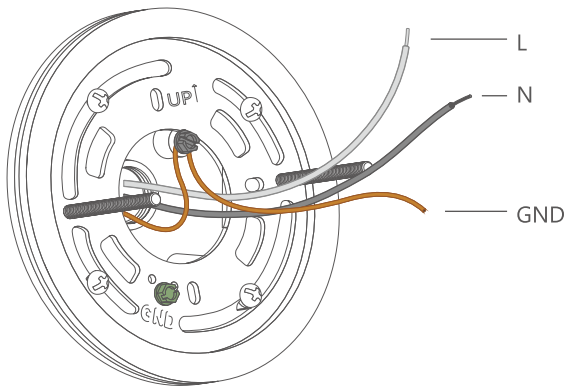

E. Use the provided hook to hang floodlight cam from the bracket while connecting the wires.

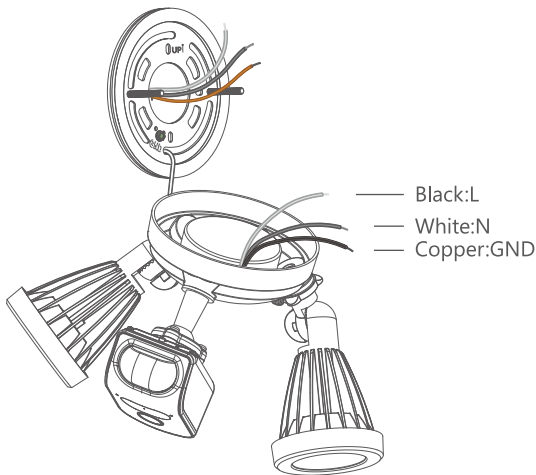

F. Use a wire nut to connect the white wire to the neutral wire coming out of your junction box.

The black wire from the floodlight cam is a hot wire.

Connect this wire to the hot wire coming out of your junction box using another wire nut.

Connect the ground wire to the green ground screw on the bracket and the existing ground wire inside your junction box. Use one of the supplied wire nuts if necessary.

(Black:L White:N Copper:GND)

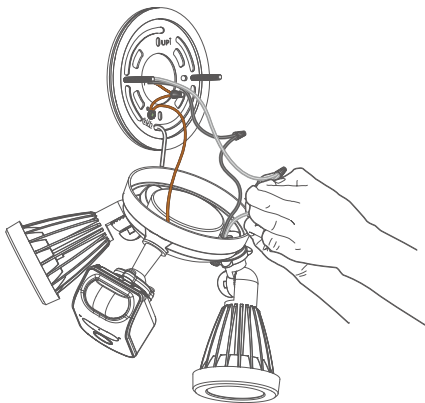

G. Carefully push all the wires through the large opening in the bracket. Align the mounting posts with the holes on floodlight cam and press together, securing the screw cap nuts with the screwdriver.

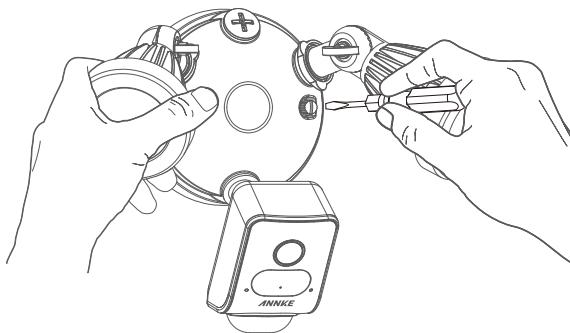

Restore power

After restoring power, the lights will turn on and your Floodlight Cam will begin speaking to you to let you know it's in setup mode.



Download And Install The App

Download and install "CAMB" APP from APP Store or Google Play.

Register and login

Open the app, click "New user" to register new account, if you already have an existing account, please click "Login".

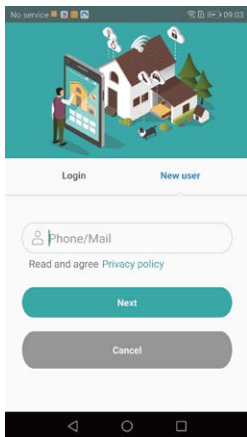
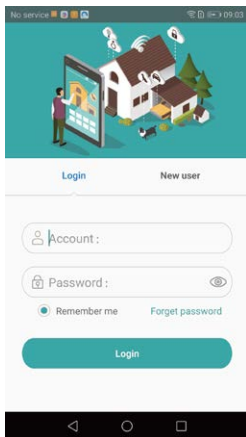

Add device

When the camera is charged, the red indicator turns on first and then, blinks after 15 seconds.

(If the blue indicator blinks, please reset the camera by pressing and holding the "reset" key for 3 seconds and then releasing. Please wait for another 15 seconds.)

After login, go to the homepage of the APP and click "+" to add a new device.

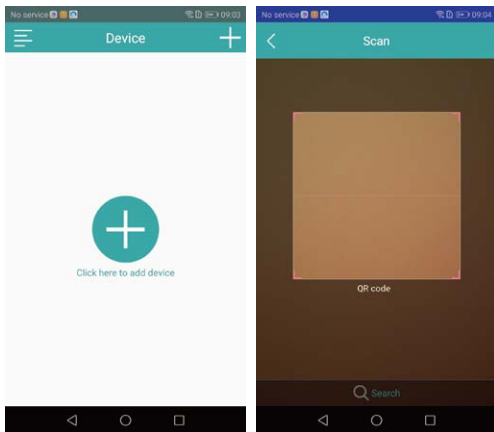

Scan the QR code on the back of the camera and add it to the app. Please make sure the WiFi signal is strong and stable.

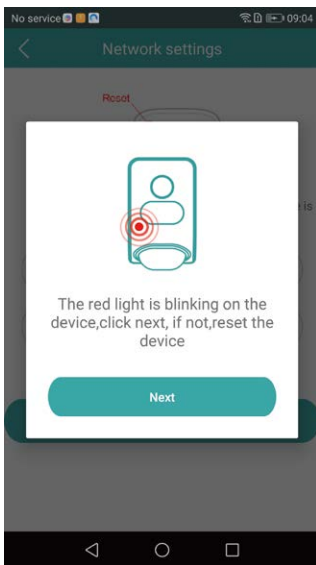

After scanning QR code, click "next" to enter "network setting" page. Please choose the 2.4 GHz network and enter the WiFi password then click "next".

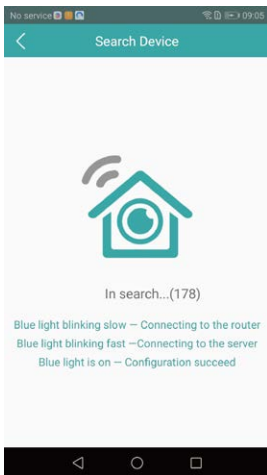
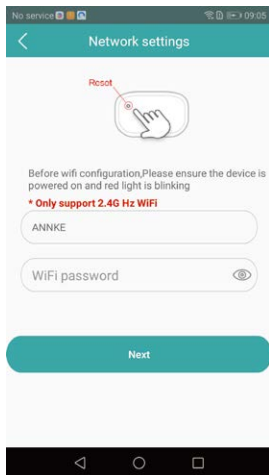

The blue light of the camera will be blinking for a while and then keeps on. Please be patient.

After successfully adding the camera, you can rename this device.

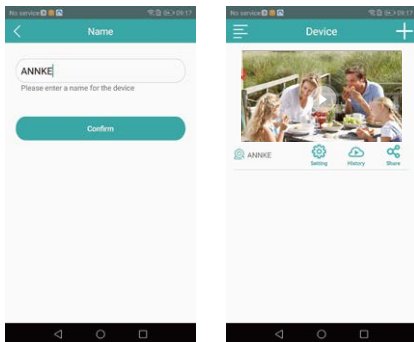





Congratulations! Device has been successfully connected!

Noted:

- . This camera only supports 2.4GHz WiFi network, Please do not choose 5GHz network.
- . Do not use non-english letter in WiFi name.
- . Do not use a WiFi without password for your privacy.
- . Do not support WEP encryption.

During live video, you can access these features:

-  Warning light
-  Video recording
-  Lighting control
-  Speaker
-  Print Screen

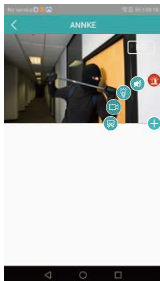

Click the "Setting" button to access the secondary menu of "Security Setting". Then, in the "Light Setting", you can set "floodlight time" and "PIR sensitivity".

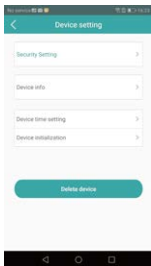

PIR sensing zone is divided into two 120° sectors: left and right, they can be switched on and off independently. As shown in the following picture.

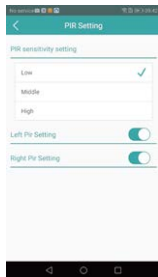
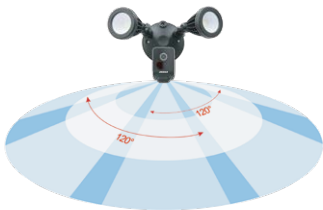

PIR sensibility settings:

The low, middle and high modes are illustrated as sectors with different colors in the picture. The color changes represent changes of the PIR sensing distance. Low sensitivity mode has shorter sensing distance, while high sensitivity mode has longer sensing distance.

Camera video recording and alert pushing

A moving object can be detected by the camera either during the day or night with lights turned on, alarm triggered, video recorded, and a notification pushed to the cell phone through the app.

Click alarm messages to enter cloud video recording page for alarm event video review. If you didn't purchase cloud recording, click "SD Video" for video review.

Click cloud storage icon on the homepage, you can also enter cloud recording page for alarm event video review.

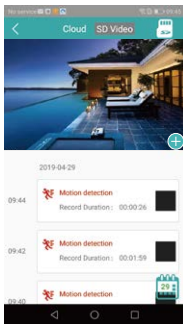

NOTED: When cloud storage is not available, alarm event can also be recorded by the SD card.

Click "security settings" to enter MD(Motion Detection) settings.

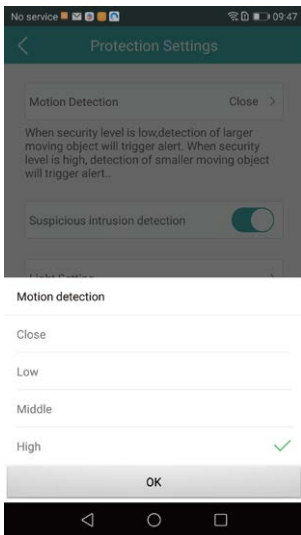

The Motion Detection sensibility contains four modes: Close, Low, Middle and High corresponding to the size of the moving object to be detected.

Higher sensibility enables the camera to detect smaller objects and trigger the alarm and video recording at the same time.

Click "Motion zones" to select the motion detection area. The detection area is selected by clicking each square on the screen.



Motion Detection can be only triggered within the selected area. The default selection is the entire area.

Suspicious intrusion detection

Click "suspicious intrusion detection" the camera only alert to the approaching suspicious objects and push notification. (All kinds of false alarms can be avoided such as light changes, tree leave movements and passing cars)

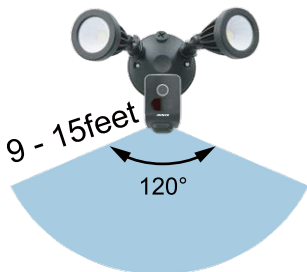

Camera sharing

Click the share icon on the homepage to share the camera videos with friends and family members. The person who receives the camera share only has the permission to view. Camera control is not allowed in this situation.

FAQ

• I'm having issues with video/audio quality and/or load times.

Issues with video and/or audio are usually related to problems with Wi-Fi signal strength or Internet speed. For an optimal experience, we recommend Internet speeds of at least 1–2Mbps. Check your Internet speed by

• How to set up PIR sensitivity and sensing area?

PIR setting only controls lighting, please set it up according to the installation environment. PIR does not trigger camera recording or alarm. When it is dark, please set the PIR sensitivity to "High" mode so that the light can be turned on earlier than the camera, providing lighting for video recording. Camera doesn't have infrared light.

• How to set up camera motion detection and Suspicious intrusion detection?

Camera motion detection (MD) and Suspicious intrusion detection (HD) only control video recording and alarm. MD and HD do not trigger lighting.



For more information,
please visit:

www.annke.com



Manufacturer: Shenzhen Kean Digital co., Ltd.
Address: 10th Floor, Rujun Building, NO. 105, The
Center Road, Bantian Street, Longgang
District, Shenzhen, 518129,China
For technical help please visit help.annke.com
Tech support: support@annke.com

