

Regulatory Information**FCC Information**

Please take attention that changes or modification not expressly approved by the party responsible for compliance could void the user's authority to operate the equipment.

FCC compliance: This equipment has been tested and found to comply with the limits for a Class A digital device, pursuant to part 15 of the FCC Rules. These limits are designed to provide reasonable protection against harmful interference when the equipment is operated in a commercial environment. This equipment generates, uses, and can radiate radio frequency energy and, if not installed and used in accordance with the instruction manual, may cause harmful interference to radio communications. Operation of this equipment in a residential area is likely to cause harmful interference in which case the user will be required to correct the interference at his own expense.

FCC Conditions

This device complies with part 15 of the FCC Rules. Operation is subject to the following two conditions:

1. This device may not cause harmful interference.
2. This device must accept any interference received, including interference that may cause undesired operation.

EU Conformity Statement

 This product and - if applicable - the supplied accessories too are marked with "CE" and comply therefore with the applicable harmonized European standards listed under the Low Voltage Directive 2014/35/EU, the EMC Directive 2014/30/EU, the RoHS Directive 2011/65/EU.

 2012/19/EU (WEEE directive): Products marked with this symbol cannot be disposed of as unsorted municipal waste in the European Union. For proper recycling, return this product to your local supplier upon the purchase of equivalent new equipment, or dispose of it at designated collection points. For more information see: www.recyclethis.info.

 2006/66/EC (battery directive): This product contains a battery that cannot be disposed of as unsorted municipal waste in the European Union. See the product documentation for specific battery information. The battery is marked with this symbol, which may include lettering to indicate cadmium (Cd), lead (Pb), or mercury (Hg). For proper recycling, return the battery to your supplier or to a designated collection point. For more information see: www.recyclethis.info.

Industry Canada ICES-003 Compliance

This device meets the CAN ICES-3 (A)/NMB-3(A) standards requirements.

Warning

This is a class A product. In a domestic environment this product may cause radio interference in which case the user may be required to take adequate measures.



Safety Instruction

These instructions are intended to ensure that user can use the product correctly to avoid danger or property loss.

The precaution measure is divided into "Warnings" and "Cautions".

Warnings: Serious injury or death may occur if any of the warnings are neglected.

Cautions: Injury or equipment damage may occur if any of the cautions are neglected.

	
Warnings Follow these safeguards to prevent serious injury or death.	Cautions Follow these precautions to prevent potential injury or material damage.

 **Warnings**

- In the use of the device, you must be in strict compliance with the electrical safety regulations of the nation and region.
- Input voltage should meet both the SELV (Safety Extra Low Voltage) and the Limited Power Source with 12 VDC according to the IEC60950-1 standard. Refer to technical specifications for detailed information.
- Do not connect multiple devices to one power adapter to avoid over-heating or a fire hazard caused by overload.
- Make sure that the plug is firmly connected to the power socket.
- Make sure that the device is firmly fixed if wall mounting or ceiling mounting is adopted.
- If smoke, odor or noise rise from the device, turn off the power at once and unplug the power cord, and then contact the service center.
- Never attempt to disassemble the camera by unprofessional personal.

 **Cautions**

- Do not drop the camera or subject it to physical shock.
- Do not touch sensor modules with fingers.
- Do not place the camera in extremely hot, cold (the operating temperature shall be -40°C to 60°C), dusty or damp locations, and do not expose it to high electromagnetic radiation.
- If cleaning is necessary, use clean cloth with a bit of ethanol and wipe it gently.
- Do not aim the camera at the sun or extra bright places.
- The sensor may be burned out by a laser beam, so when any laser equipment is in using, make sure that the surface of sensor will not be exposed to the laser beam.
- Do not expose the device to high electromagnetic radiation or extremely hot, cold, dusty or damp environment.
- To avoid heat accumulation, good ventilation is required for the operating environment.
- Keep the camera away from liquid while in use for non-water-proof device.
- While in delivery, the camera shall be packed in its original packing, or packing of the same texture.

1 Introduction**1.1 Product Features**

The main features are as follows:

- High performance CMOS sensor
- IR cut filter with auto switch
- OSD menu with configurable parameters
- Auto white balance
- Internal synchronization
- SMART IR mode
- Visible alarm
- PIR detection
- 3-axis adjustment

1.2 Overview

Figure 1-1 Camera Overview

ANNKE

TURBO HD

5MP PIR Turret Camera

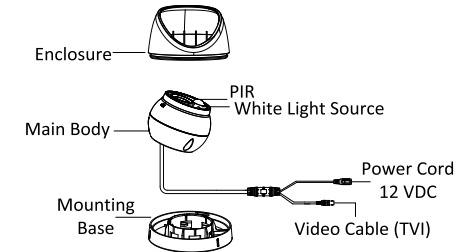
User Manual

User Manual

Thank you for purchasing our product. If there are any questions, or requests, do not hesitate to contact the dealer.

This manual may contain technical incorrect places or printing errors, and the content is subject to change without notice. The updates will be added to the new version of this manual. We will readily improve or update the products or procedures described in the manual.

2 Installation

Before you start:

- Make sure that the device in the package is in good condition and all the assembly parts are included.
- Make sure that all the related equipment is power-off during the installation.
- Check the specification of the products for the installation environment.
- Check whether the power supply is matched with your required output to avoid damage.
- Make sure the wall is strong enough to withstand three times the weight of the camera, and the mount.
- If the wall is cement, insert expansion screws before installing the camera. If the wall is wooden, use self-tapping screw to secure the camera.
- If the product does not function properly, contact your dealer or the nearest service center. Do NOT disassemble the camera for repair or maintenance by yourself.

2.1 Ceiling/Wall Mounting without Junction Box

Steps:

1. Disassemble the camera.
 - 1). Rotate the camera to align the notch to one of the marks.
 - 2). Pry the mounting base to remove the mounting base with the camera body with a flat object, e.g., a coin.

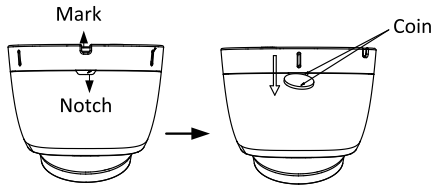

2. Paste the drill template (supplied) to the place where you want to install the camera.
3. Drill the screw holes, and the cable hole (optional) in the ceiling/wall according to the drill template.



Figure 2-1 Drill Template

Note:

Drill the cable hole, when adopting the ceiling outlet to route the cable

4. Attach the mounting base to the ceiling/wall, and secure them with supplied screws

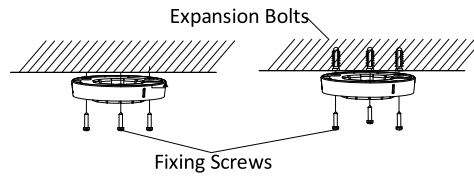

Figure 2-2 Attach the Mounting Base to the Ceiling

Note:

- The supplied screw package contains self-tapping screws, and expansion bolts.
 - For cement wall/ceiling, expansion bolts are required to fix the camera. For wooden wall/ceiling, self-tapping screws are required.
5. Route the cables through the cable hole, or the side opening.
 6. Align the camera with the mounting base, and secure the camera on the mounting base.

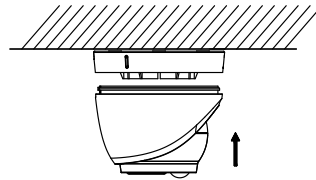

Figure 2-3 Secure the Camera with Mounting Base

7. Connect the corresponding cables, such as power cord, and video cable.
8. Power on the camera to check whether the image on the monitor is gotten from the optimum angle. If not, adjust the camera according to the figure below to get an optimum angle.

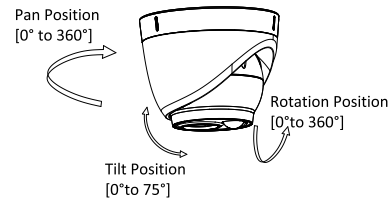

Figure 2-4 3-axis Adjusts

- 1). Hold the camera body and rotate the enclosure to adjust the pan position [0° to 360°].
- 2). Move the camera body up and down to adjust the tilt position [0° to 75°].
- 3). Rotate the camera body to adjust the rotation position [0° to 360°].

2.2 Mounting with Inclined Ceiling Mount

Before you start:

You need to purchase an inclined ceiling mount separately.

Steps:

1. Paste the drill template (supplied) to the place where you want to install the camera.
2. Drill screw holes, and the cable hole on the ceiling/wall according to the supplied drill template.

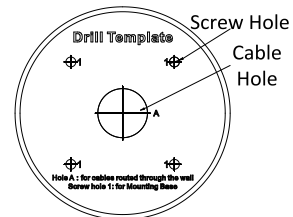

Figure 2-5 The Drill Template

3. Disassemble the inclined ceiling mount by the screw driver.
4. Install the turret camera's mounting base on the inclined ceiling mount's cover with three PM4 screws.

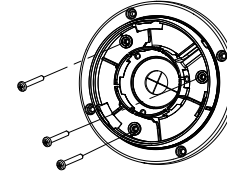

Figure 2-6 Install Turret Camera's Mounting Base

5. Install the inclined ceiling mount's body on the ceiling/wall with four PA4 × 25 screws, as shown in Figure 2-8.

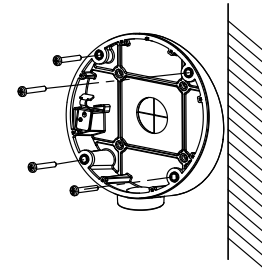

Figure 2-7 Fix the Inclined Ceiling Mount's Body

6. Combine the inclined ceiling mount's cover with its body with supplied screws.
7. Repeat steps 5 to 8 of the 2.1 Ceiling/Wall Mounting without Junction Box to complete the installation.

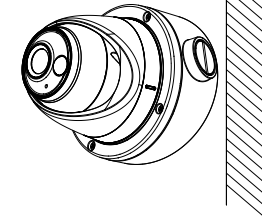

Figure 2-8 Fix the Camera to the Inclined Ceiling Mount

2.3 Ceiling/Wall Mounting with Junction Box

Before you start:

You need to purchase a junction box separately.

Steps:

1. Paste the drill template on the ceiling/wall.

2. Drill screw holes and the cable hole (optional) in the ceiling/wall according to the holes of the drill template.

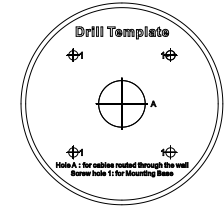

Figure 2-9 Drill Template of the Junction Box

Note:

Drill the cable hole, when adopting the ceiling outlet to route the cable.

3. Take apart the junction box, and align the screw holes of the turret camera's mounting base with those on junction box's cover.
4. Fix the mounting base on junction box's cover by supplied screws.

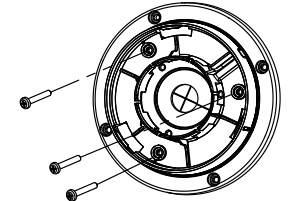

Figure 2-10 Install Turret Camera's Mounting Base

5. Secure the junction box's body with supplied screws on the ceiling/wall.

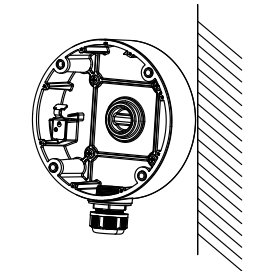

Figure 2-11 Install the Junction Box' Camera Body on Ceiling/Wall

6. Combine the junction box's cover with the junction box's body.
7. Repeat steps 5 to 8 of 2.1 Ceiling/Wall Mounting without Junction Box to install the camera to the junction box.

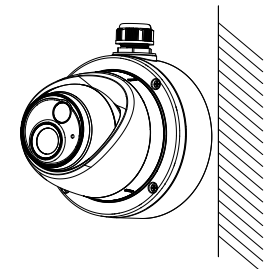

Figure 2-12 Fix the Camera to the Junction Box

2.4 Wall Mounting

Before you start:

You need to purchase a wall mount separately.

Steps:

1. Drill four screw holes in the wall according to the holes of the mount.
2. Install the mount to the wall by aligning the four screw holes of the bracket with expansion screws on the wall.
3. Secure the mount with four hex nuts and washers.

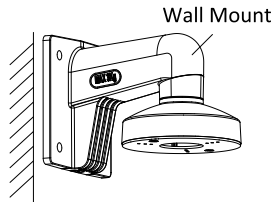

Figure 2-13 Install the Bracket

4. Install the mounting base of the turret camera to the wall mount, and secure them with supplied screws.

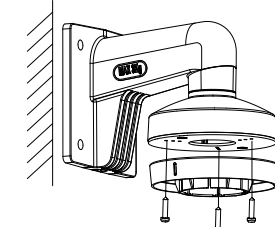

Figure 2-14 Install the Mounting Base to the Bracket

5. Route the cables through the mount.
6. Repeat steps 6 to 8 of 2.1 Ceiling/Wall Mounting without Junction Box to complete the installation.

3 Menu Description

Please follow the steps below to call the menu.

Note:

The menu description part is only for your reference. It might have some differences due to the specific model that you have.

Steps:

1. Connect the camera with the TVI DVR, and the monitor, shown as the figure 3-1.

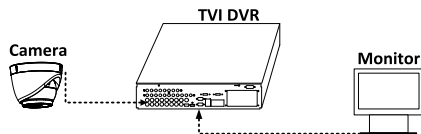



Figure 3-1 Connection

2. Power on the analog camera, TVI DVR, and the monitor to view the image on the monitor.
3. Click PTZ Control to enter the PTZ Control interface.

4. Call the camera menu by clicking  button, or call the preset No. 95.

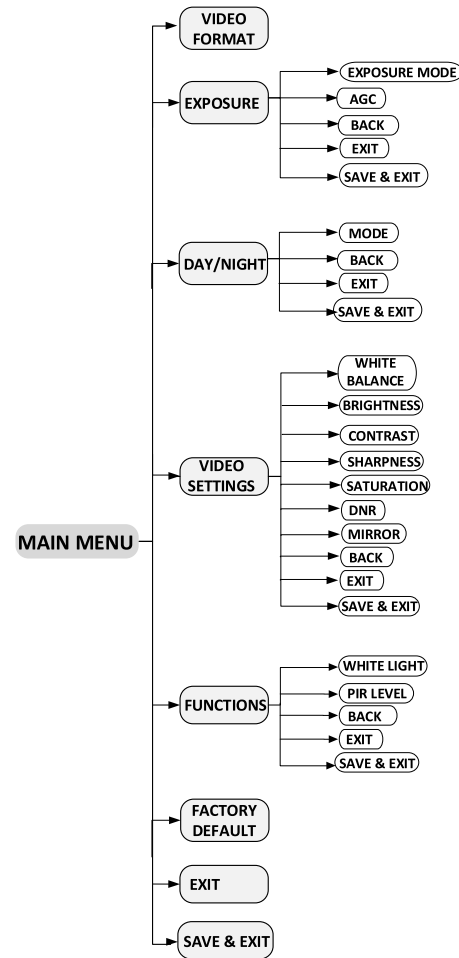

Figure 3-2 Main Menu Overview

5. Click the direction arrow to control the camera.
 - 1). Click up/down direction button to select the item.
 - 2). Click Iris + to confirm the selection.
 - 3). Click left/right direction button to adjust the value of the selected item.

3.1 VIDEO FORMAT

You can select the video format as 5MP @ 20fps, 4MP @ 25fps, 4MP @ 30fps, 2MP@25fps , or 2MP@30fps.

3.2 EXPOSURE

EXPOSURE MODE

You can set the **EXPOSURE MODE** as **GLOBAL**, **BLC**, or **DWDR**.

● GLOBAL

GLOBAL refers to the normal exposure mode which adjusts lighting distribution, variations, and non-standard processing.

● BLC (Backlight Compensation)

BLC (Backlight Compensation) compensates light to the object in the front to make it clear, but this may cause the over-exposure of the background where the light is strong.

● DWDR (Digital Wide Dynamic Range)

The digital wide dynamic range helps the camera provide clear images even under backlight circumstances. **WDR** balances the brightness level of the whole image and provides clear images with details.

AGC (Auto Gain Control)

It optimizes the clarity of the image in poor light conditions. The **AGC** level can be set as **HIGH**, **MEDIUM**, or **LOW**. Select **OFF** to disable the **AGC** function.

Note:

The noise will be amplified when the **AGC** is on.

3.3 DAY/NIGHT

COLOR, **B&W** (Black White), and **AUTO** are selectable for **DAY** and **NIGHT** switches.

COLOR

The image is colored in day mode all the time.

B/W

The image is black and white all the time, and it is better to turn the **IR LIGHT** on in poor light conditions.

● IR LIGHT

You can turn on/off the **IR LIGHT** to meet the requirements of different circumstances.

● SMART IR

The **Smart IR** function is used to adjust the light to its most suitable intensity, and prevent the image from over exposure. The **SMART IR** value can be adjusted from 0 to 3. The greater the value is, the more obvious effects are.

AUTO

You can turn on/off the **IR LIGHT**, and set the value of **SMART IR** in this menu.



Figure 3-3 DAY NIGHT

● IR LIGHT

You can turn on/off the infrared to meet the requirements of different circumstances.

● SMART IR

The **Smart IR** function is used to adjust the light to its most suitable intensity, and prevent the image from over exposure. The **SMART IR** value can be adjusted from 0 to 3. The higher the value is, the more obvious effects are.

● D-N THRESHOLD (Day to Night Threshold)

Day to Night Threshold is used to control the sensitivity of switching the day mode to the night mode. You can set the value from 1 to 9. The larger the value is, the more sensitive the camera is.

● N-D THRESHOLD (Night to Day Threshold)

Night to Day Threshold is used to control the sensitivity of switching the night mode to the day mode. You can set the value from 1 to 9. The larger the value is, the more sensitive the camera is.

3.4 VIDEO SETTINGS

Move the cursor to **VIDEO SETTINGS** and click Iris+ to enter the submenu. **CONTRAST**, **SHARPNESS**, **COLOR GAIN**, **3 DNR**, and **MIRROR** are adjustable.



Figure 3-4 VIDEO SETTING

WHITE BALANCE

White balance, the white rendition function of the camera, is to adjust the color temperature according to the environment. It can remove unrealistic color casts in the image. You can set **WHITE BALANCE** mode as **AUTO**, or **MANUAL**.

● AUTO

Under **AUTO** mode, white balance is being adjusted automatically according to the color temperature of the scene illumination.

● MANUAL

You can set the **R-GAIN/B-GAIN** value from 1 to 255 to adjust the shades of red/blue color of the image.

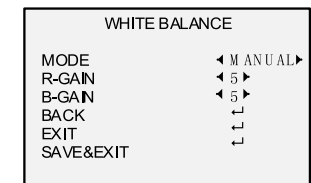

Figure 3-5 MWB MODE

BRIGHTNESS

Brightness refers to the brightness of the image. You can set the brightness value from 1 to 9 to darken or brighten the image. The greater the value is, the brighter the image is.

CONTRAST

This feature enhances the difference in color and light between parts of an image. You can set the **CONTRAST** value from 1 to 9.

SHARPNESS

Sharpness determines the amount of detail an imaging system can reproduce. You can set the **SHARPNESS** value from 1 to 9.

SATURATION

Adjust this feature to change the saturation of the color. The value ranges from 1 to 9.

DNR (Digital Noise Reduction)

The **DNR** function can decrease the noise effect, especially when capturing moving images in poor light conditions, and delivering more accurate and sharper image. You can set the **DNR** value from 1 to 9.

MIRROR

OFF, **H**, **V**, and **HV** are selectable for mirror.

OFF: The mirror function is disabled.

H: The image flips 180° horizontally.

V: The image flips 180° vertically.

HV: The image flips 180° both horizontally and vertically.

3.5 FUNCTIONS

3.5.1 WHITE LIGHT

The embedded white light source can be worked as the visible alarm.

In the **WHITE LIGHT** mode, you can set the mode as **ALARM**, or **OFF**.

When you select the **WHITE LIGHT** as **ALARM**, you can set the Parameters in the **TRIGGER MODE**, and the **ALARM MODE** to meet your needs.

TRIGGER MODE

● DVR

Select the **TRIGGER MODE** as **DVR**. In this way, the alarm signal is sent from the DVR, and the camera works as the alarm detector in the process. Besides, the alarm type only supported by the DVR can also triggers the visible alarm in the camera.

● CAMERA

Select the **TRIGGER MODE** as **CAMERA**, the embedded PIR module sends the alarm signal to the visible alarm in the camera, when PIR module detected the alarm source.

ALARM

In the **ALARM** mode, you can select the **ALARM MODE** as **SOLID**, or **FLASHING**.

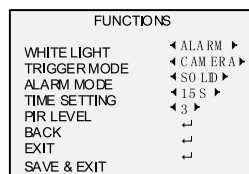

Figure 3-6 ALARM MODE

● SOLID

Select the **ALARM MODE** as **SOLID**. In this way, the white light source turns on, when the PIR module received the alarm signal. In the **TIME SETTING** you can set the time as 5 s, 10 s, 15 s, 30 s, or 60 s, which means that the solid mode stays for the set time when the camera received one alarm signal.

Note:

The solid mode will be stayed for another set time when second alarm signal is received, and the rest can be done in the same way.

● FLASHING

Select the **ALARM MODE** as **FLASHING**. In this way, the white light source flashes when the PIR module received the alarm signal.

OFF

Select **OFF** to give up this function.

3.5.2 PIR LEVEL

Adjust the sensitivity of the PIR module, and the higher the value is, the more sensitive the PIR module is.

3.6 FACTORY DEFAULT

Reset all the settings to the factory default.

3.7 EXIT

Move the cursor to **EXIT** and click Iris+ to exit the menu.

3.8 SAVE & EXIT

Move the cursor to **SAVE & EXIT** and click Iris+ to save the settings, and exit the menu.

ANNKE

BEDIENUNGSANLEITUNG CCTV KAMERA

DE

PRODUKTEIGENSCHAFTEN

- High-Performance Chips, hohe Auflösung, klare und feine Bilder
- Unterstützt automatischen Weißabgleich, hohe Farbanpassung, realistisches Bild
- Unterstützt automatische elektronische Klappe, Anpassung an verschiedene Monitoring-Umgebungen
- Hohes S/N-Verhältnis, das Bild ist klar und angenehm für die Augen
- Unterstützt Privatzenonabdeckung, BLC und digitale, breite Dynamik-Funktion
- Unterstützt Auto-AGC, automatische Helligkeitsanpassung
- Fortschrittliche doppelt verglaste Struktur, kein Lichtaustritt
- Lange Lebensdauer
- Einfache Installation und Fehlersuche

INSTALLATION

Mit DVR als Überwachungs-Mainframe

Erforderliche Ausrüstung: Kamera, Halterung (Dome Kamera unnötig); Netzteil; Kabel; DVR; Festplatte (HDD); Monitor oder Fernseher.

Installationsschritte:

- A. Die Installation der Festplatte in den DVR. Einschalten des DVR, dann verbinden Sie das Gerät mit der Kamera zum Debugging der gesamten Überwachungs-ausrüstung.
 - B. Installation der Kamera und Bestätigung der Position des DVR..
 - C. Verkabelung und Anschluss des Steckers der Videokamera und des DVR-Kabels.
- Siehe die Abbildungen unten für die genaue Verbindung. Hinweis: Dieser Vorgang ist nur für den Anschluss gedacht. Bitte bereiten Sie DVR, Netzteil, Videokabel vorab vor.

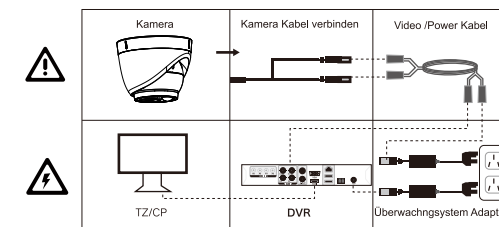

Hinweis: Dieser Vorgang ist nur für den Anschluss gedacht. Bitte bereiten Sie DVR, Netzteil, Videokabel vorab vor.



For more information,
please visit:

www.annke.com



WARNHINWEIS:

Es besteht die Gefahr eines elektrischen Schlages

Warnhinweis:

Um das Risiko eines Stromschlags zu reduzieren, sollten nur ein Techniker die vordere oder hintere Abdeckung entfernen.

Warnhinweis:

Zur Vermeidung von elektrischen Schlägen und Brandgefahr wählen Sie bitte das entsprechende Netzteil für die Kamera.

Warnhinweis:

Änderungen oder Modifikationen, die nicht durch unser Unternehmen bei der Konstruktion des Produkts genehmigt wurden, können den Betrieb durch den Benutzer beeinträchtigen.

WARNHINWEIS:

01/ Installieren Sie die Kamera nicht in einer Umgebung, die nicht im vorgeschriebenen Temperaturbereich liegt.

Installieren und verwenden Sie die Kamera in Umgebungen zwischen -20°C und ~ + 50°C und bei guter Belüftung.

02/ Verwenden Sie die Kamera nicht in Umgebungen mit hohem Druck und stark ätzenden oder anderen speziellen Umgebungen.

Dies kann dazu führen, dass die Kamera nicht richtig arbeitet oder beschädigt werden kann.

03/ Verwenden Sie die Kamera nicht an einem Ort, der voller Staub ist und an dem Gas austritt.

Dies kann dazu führen, dass die Kamera nicht mehr funktioniert.

04/ Versuchen Sie nicht, die Kamera auseinander zu nehmen.

Wenn dies notwendig ist, tun Sie es bitte unter der Anleitung von professionellen Technikern.

05/ Lassen Sie die Kamera nicht fallen und schütteln Sie sie nicht.

Dies kann dazu führen, dass die Kamera nicht mehr funktioniert.

06/ Berühren Sie das vordere Objektiv und den Sensor der Kamera nicht.

Achten Sie darauf, dass Sie keine Fingerabdrücke oder andere Flecken hinterlassen. Wenn die Kamera Blitzen oder anderem intensiven Licht ausgesetzt ist, kann das Bild unscharf werden.

Vor dem Anschluss an die Stromversorgung prüfen Sie bitte, ob diese die Anforderungen der Spezifikation erfüllt oder nicht.

Manufacturer: Shenzhen Kean Digital co., Ltd.
Address: 10th Floor, Rujun Building, NO. 105, The Center Road, Bantian Street, Longgang District, Shenzhen, 518129, China
For technical help please visit help.annke.com
Tech support: support@annke.com



Made in China